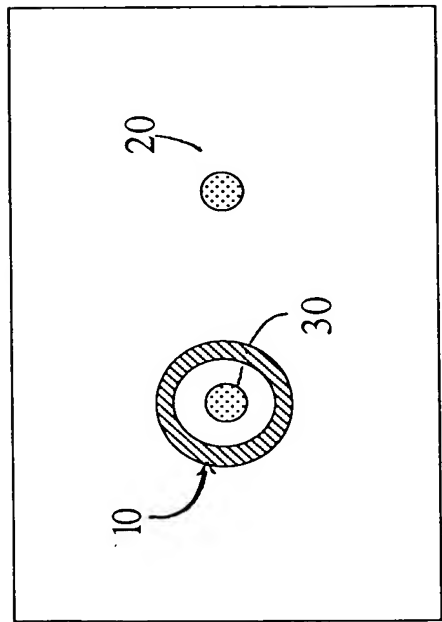
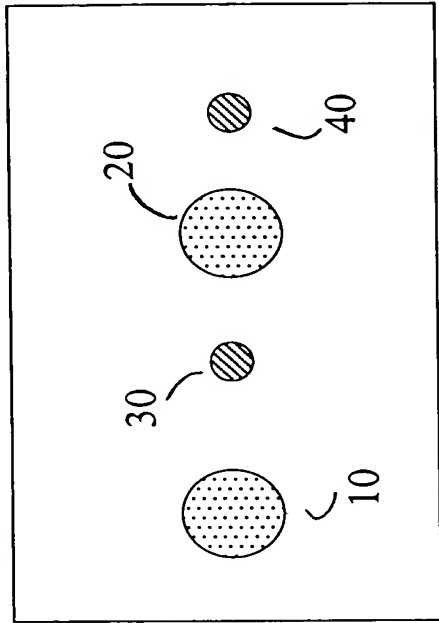

Fig. 2



A



B

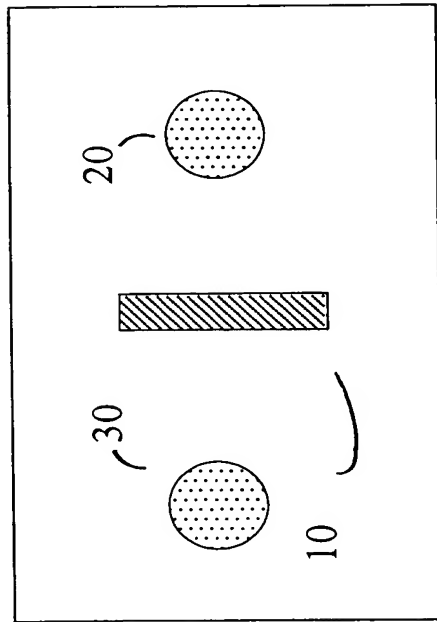

C

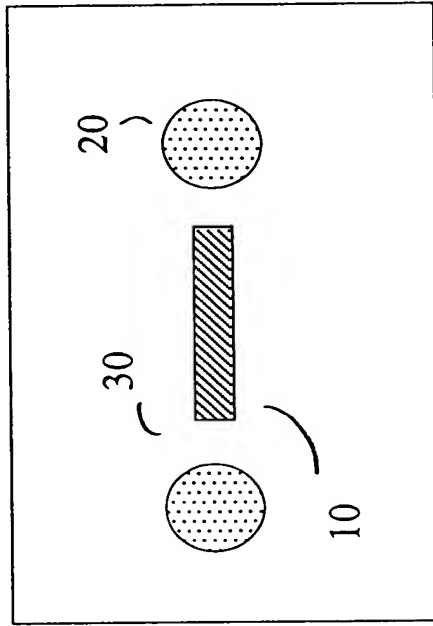

D

FIG. 3

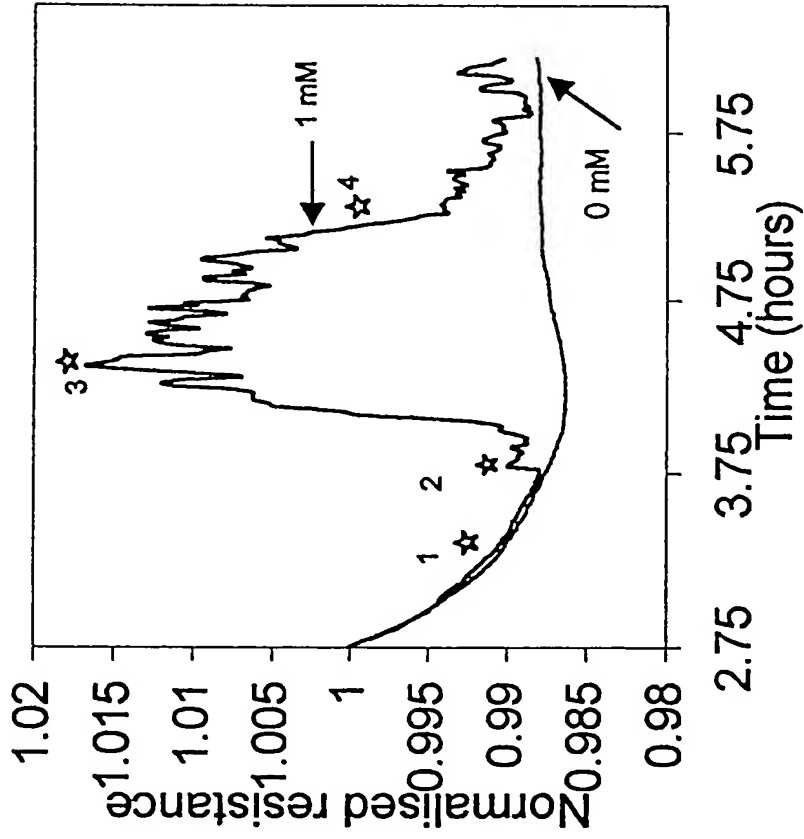
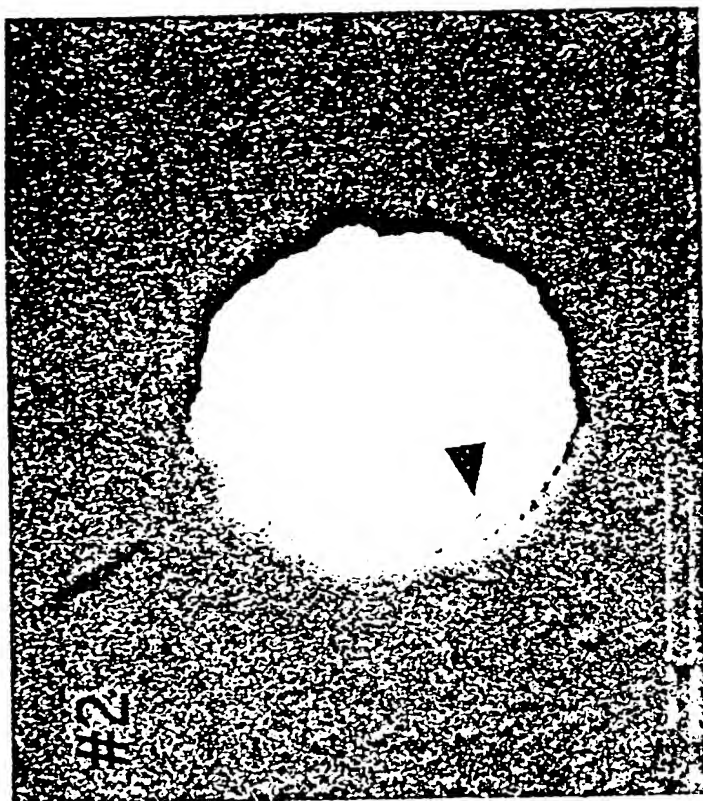
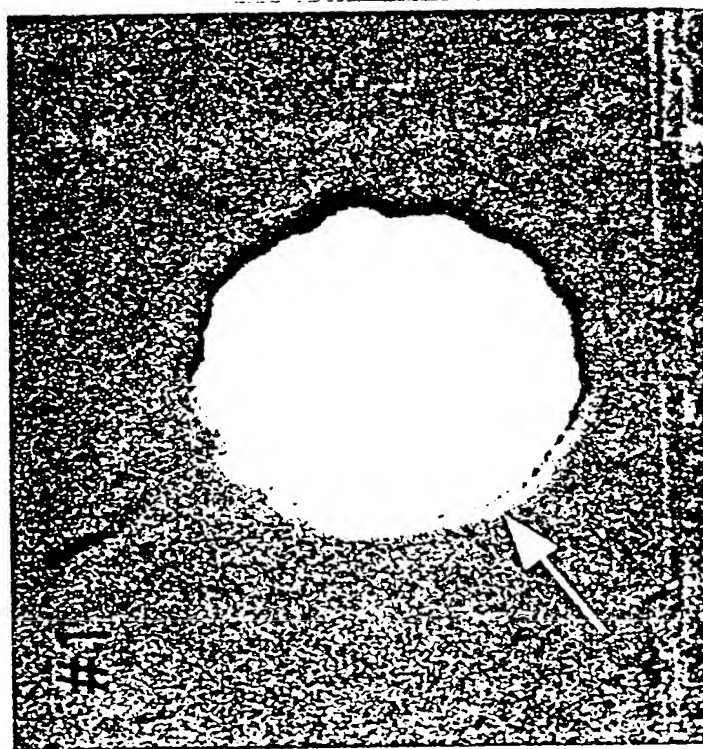

FIG. 4



B



A

FIG. 5
PANELS A-B

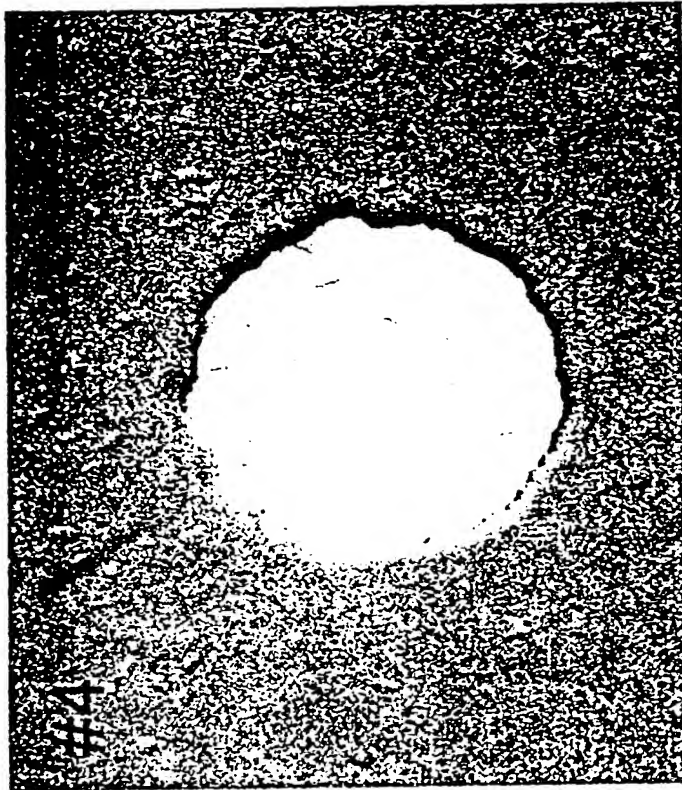

D

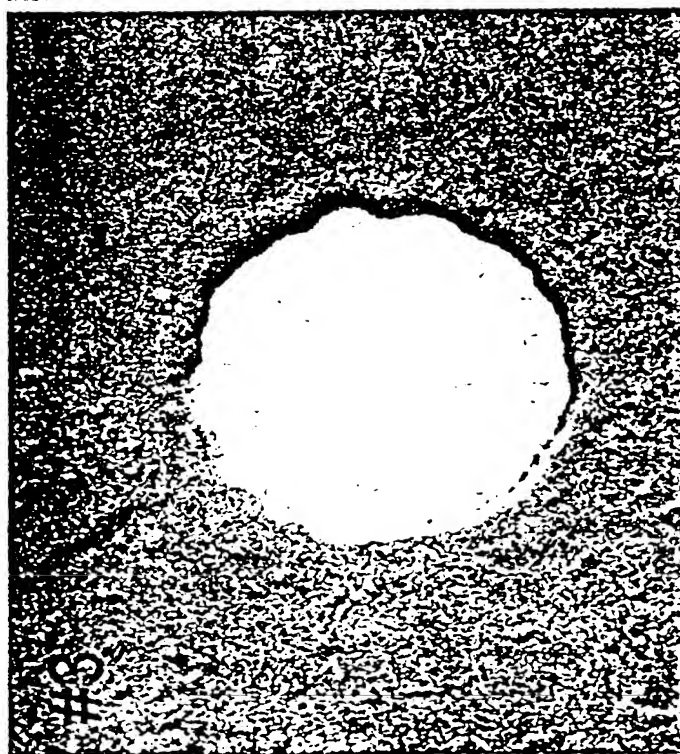

C

FIG. 5
PANELS C-D

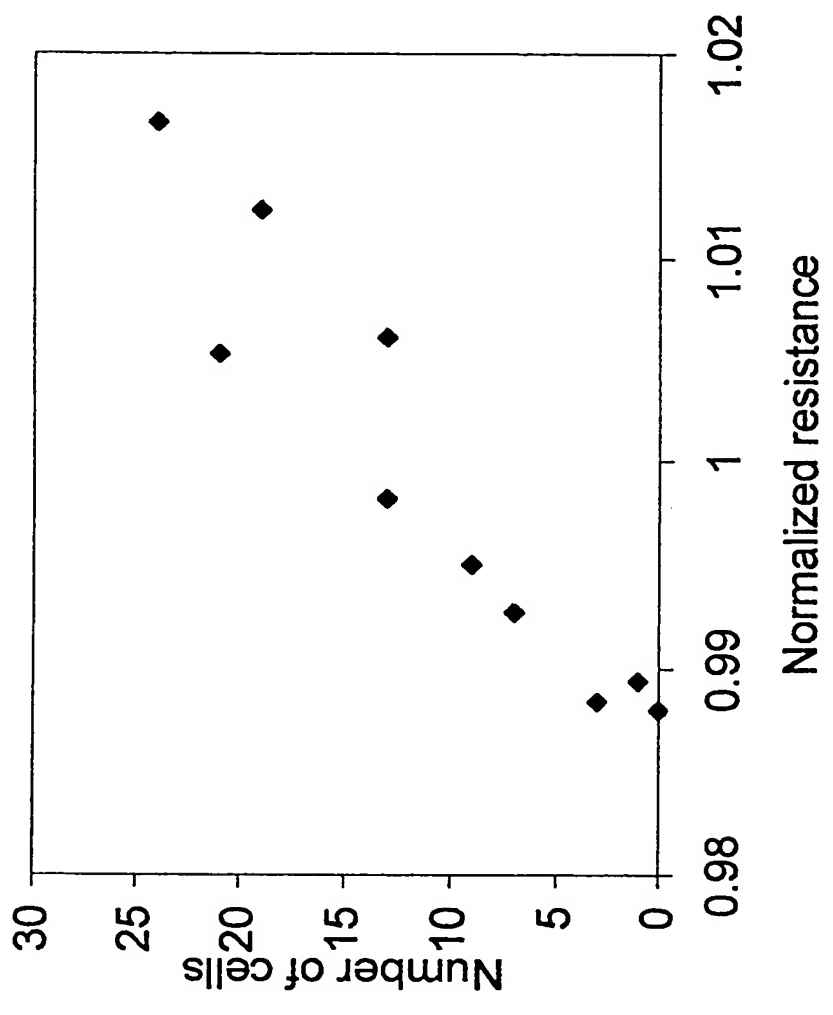

FIG. 6

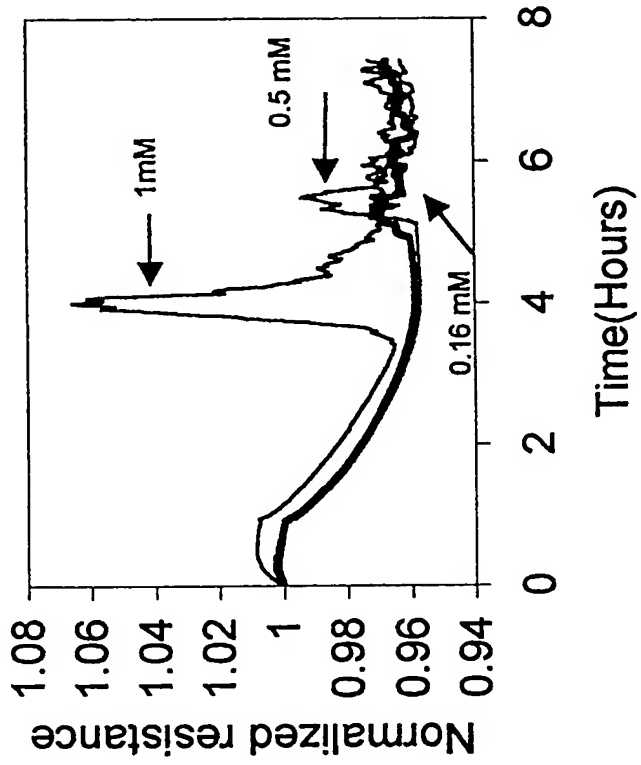

FIG. 7

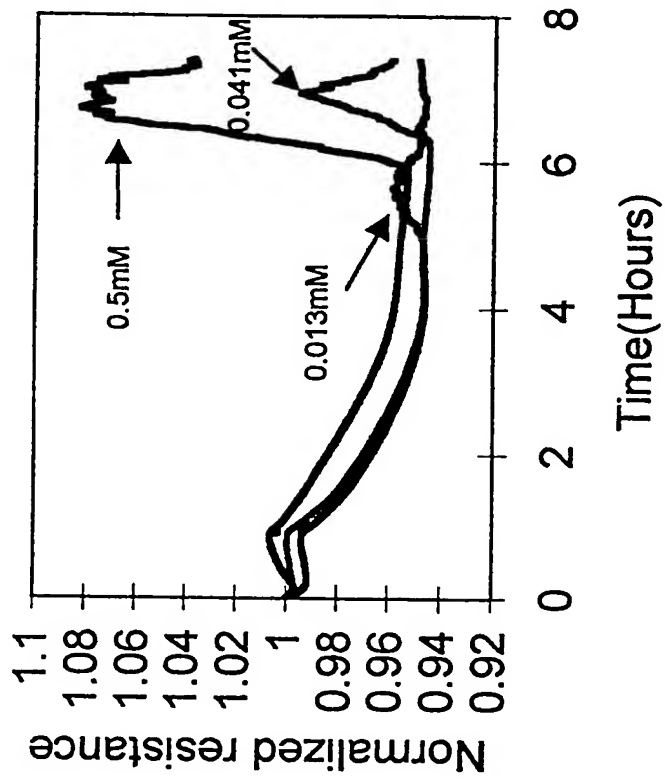

FIG. 8

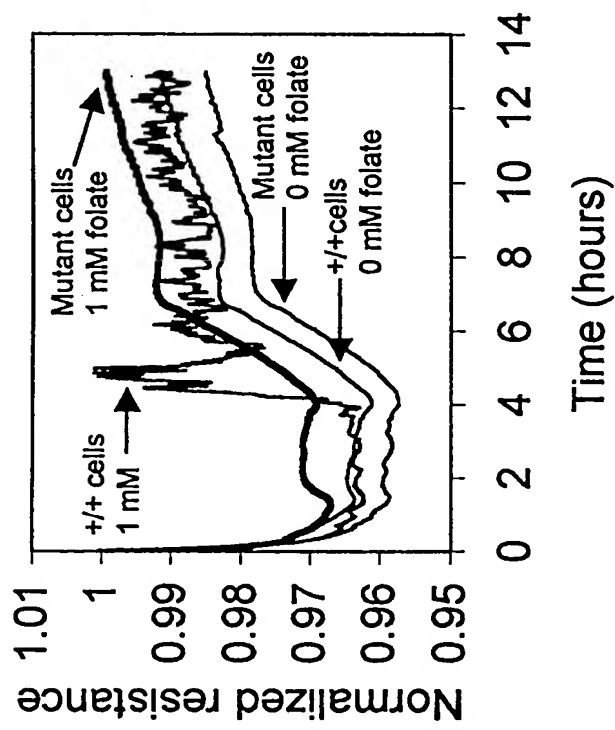

FIG. 9

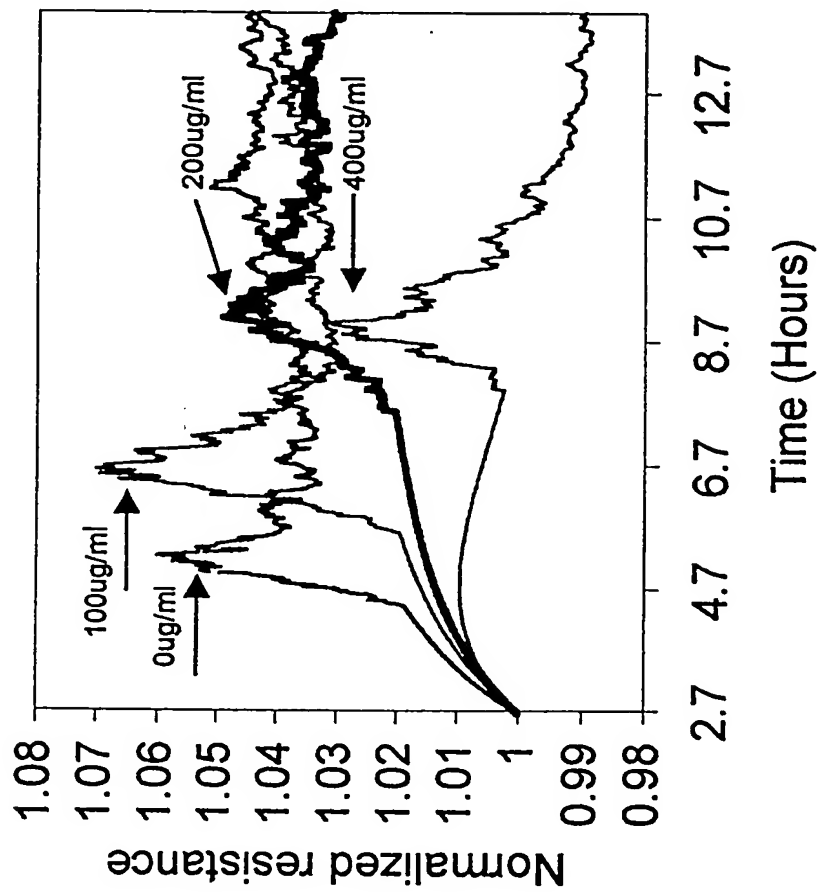

FIG. 10

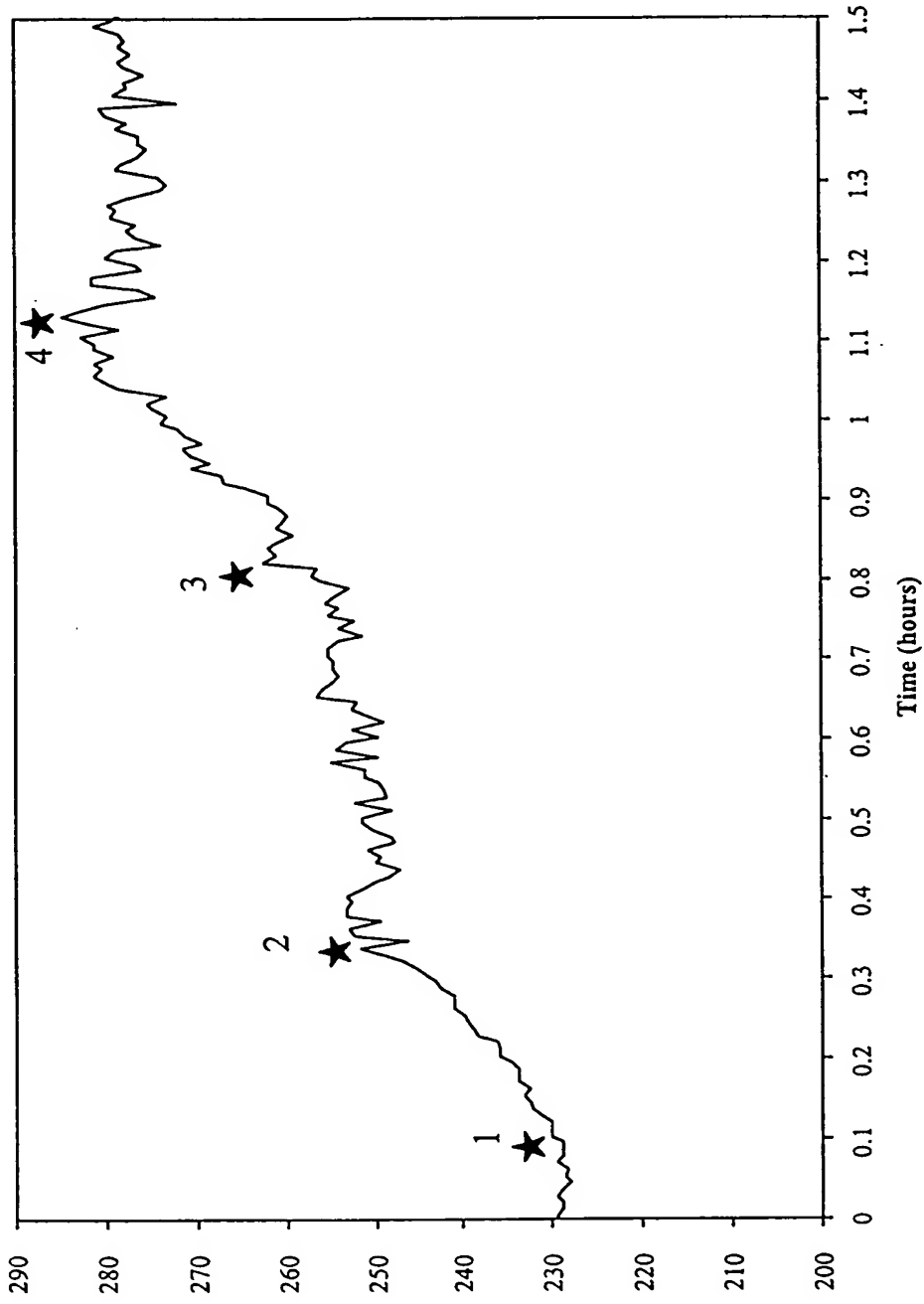
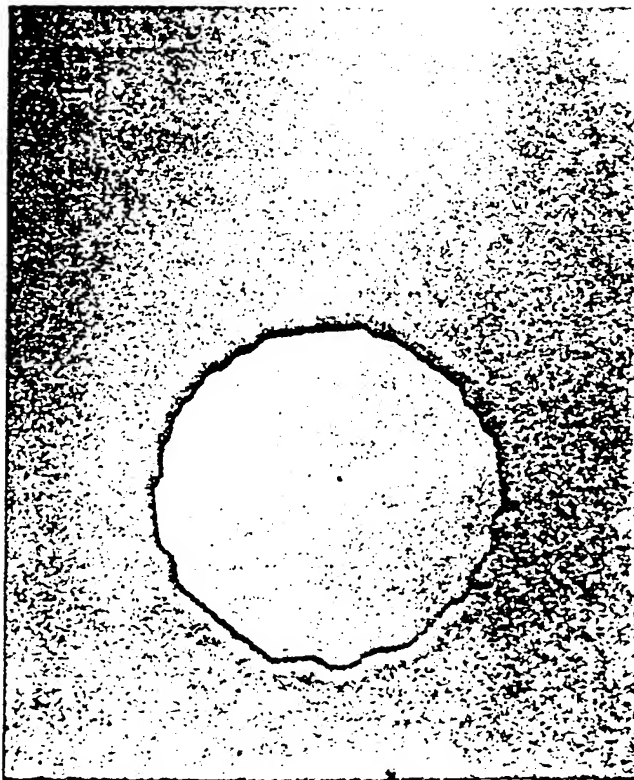
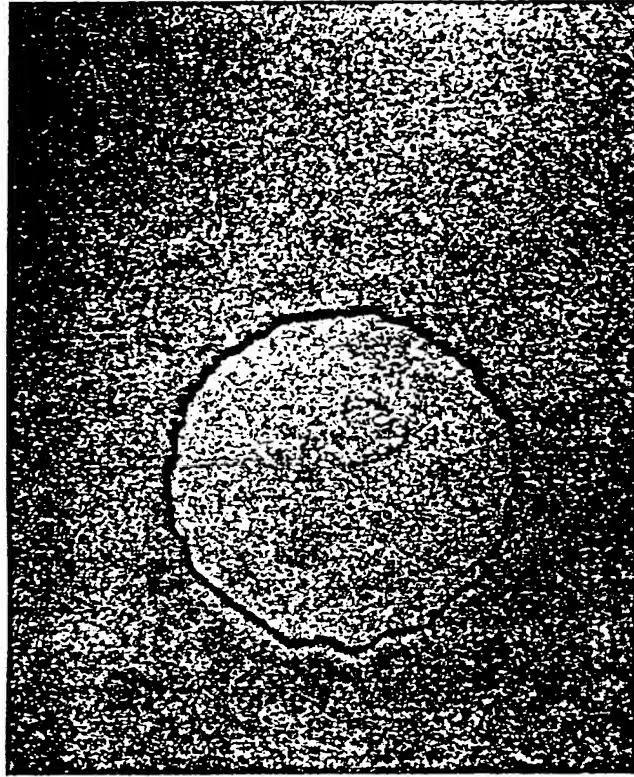

FIG. 11



A



B

FIG. 12
PANELS A-B

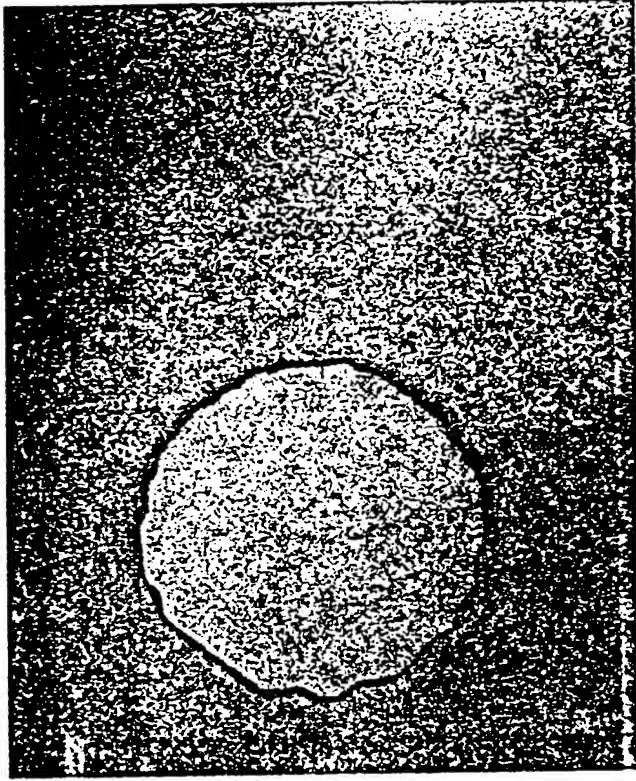

D

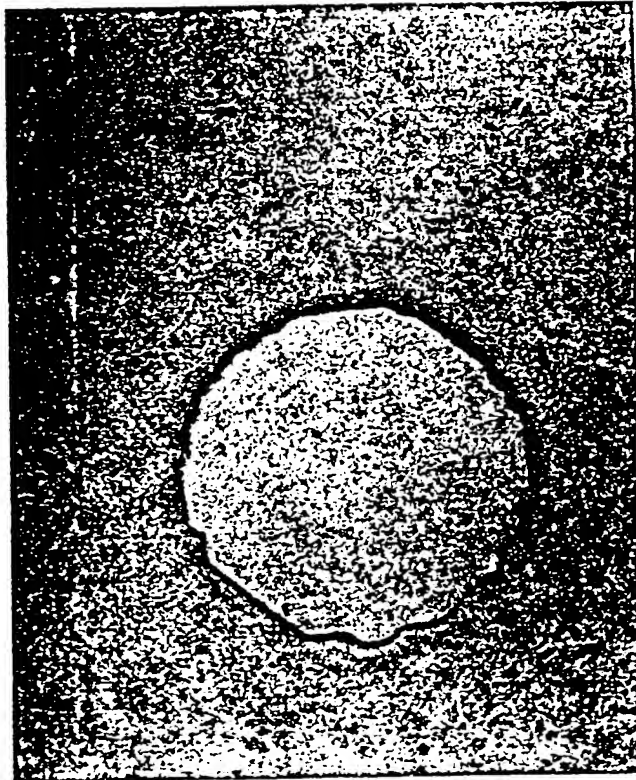

C

FIG. 12
PANELS C-D